

# **HARDI FILLMETER**

**Instruction book**

**679017-GB-2002/02**

# HARDI FILLMETER

---

## Table of Contents

Table of Contents .....	2
EC Declaration of Conformity .....	3
Operator safety .....	4
Description .....	4
Assembly .....	5
Display .....	5
Flowmeter assembly .....	6
COMMANDER Plus suction filling .....	6
COMMANDER Plus pressure filling .....	7
MEGA suction filling .....	8
MEGA pressure filling (full MANIFOLD SYSTEM) .....	8
MEGA pressure filling (basic MANIFOLD SYSTEM) .....	9
Mounting of air vent. ....	10
Mounting of tank connection with deflector plate in tank .....	10
Calibration .....	11
Basic setting .....	11
Flow setting .....	11
Example .....	12
Procedure (example) .....	12
DIP-switch setup .....	14
Operating .....	15
Suction filling using internal pump of the sprayer .....	15
Pressure filling with external pump .....	16
Maintenance .....	17
Fault finding .....	17
Technical specifications .....	18
Spare parts .....	20

**EC Declaration of Conformity**

**Manufacturer,**  
HARDI INTERNATIONAL A/S  
Helgeshøj Allé 38  
DK 2630 Taastrup  
Denmark

**Importer,**

declare that the following product;

.....  
.....

Adhere extra shipping package labels to inside cover.

Was manufactured in conformity with the provisions in the  
EMC directive 89/336/EEC, ISO14982.

# HARDI FILLMETER

---

We congratulate you for choosing a HARDI plant protection product. The reliability and efficiency of this product depend on your care. **Read and pay attention** to this instruction book. It contains information for the efficient use and long life of this quality product.

## Operator safety



Watch for this symbol. It means note, warning, and caution. Your safety is involved so be alert



Note the following recommended precautions and safe operating practices.



Read and understand this instruction book before using the equipment. It is equally important that other operators of this equipment read and understand this book.



Disconnect electrical power before disconnecting the display.

## Description

HARDI FILLMETER measures the amount of liquid filled into the spray tank. The HARDI FILLMETER is intended for water and liquid fertilizers.

The measure is given in Litres or US gallons.

The HARDI FILLMETER BASIC package is designed for the suction side of the sprayer and it utilizes the sprayer pump to aspirate the water.

BASIC package plus the HARDI FILLMETER NURSE TANK TRANSFER package is designed for the pressure side when using a nurse tank with centrifugal transfer pump.



**Note:** HARDI FILLMETER is **NOT** intended for use with HARDI Fast Filling Device.

## Assembly

### Display

The display is mounted in the bracket by means of a snap function and Velcro®.

The Velcro® secures easy removal of the display at the end of the spraying season if wanted.

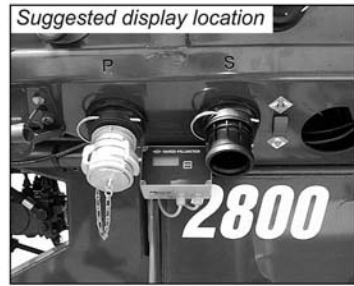

The display can be fixed to the sprayer by 2 methods:

#### A. Mounting with adhesive strips

1. Fit Velcro® to bracket and display as shown.
2. Mount display in bracket as shown.
3. Find a plane surface near the filling device, where the display is visible during filling of tank, and where it will not be damaged.
4. Clean the glue surfaces on the bracket and the sprayer with solvent.
5. Fit the 2 adhesive strips to the bracket and place it on the sprayer.
6. Lead the cables to the flowmeter and power source and connect.
7. Secure with cable ties.

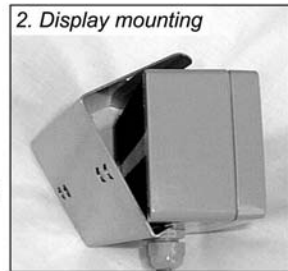
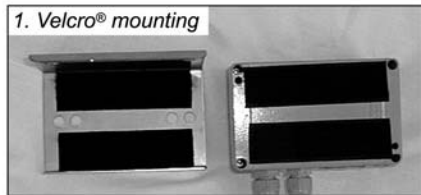

#### B. Mounting with supplied M4 screws

Same as A, except 4 and 5, instead drill holes for the supplied M4 screws.

If the manifold system is not fully occupied it is here possible to mount the bracket without drilling.



Cables must come to the display from its underside.

# HARDI FILLMETER

## Flowmeter assembly



It is recommended to lubricate all O-rings before assembly.



**Note:** The flowmeter should always be mounted at an angle larger than (or same as) 35 degrees from horizontal, viewed from its side.

## COMMANDER Plus suction filling

1. Remove manifold valve cover from platform side.
2. Demount the hose from the suction filling inlet.
3. Demount the connector by unscrewing the nut on the frontside.
4. Assemble all new parts and the unscrewed connector in same order as shown.
5. Mount the assembled parts from platform side as shown.

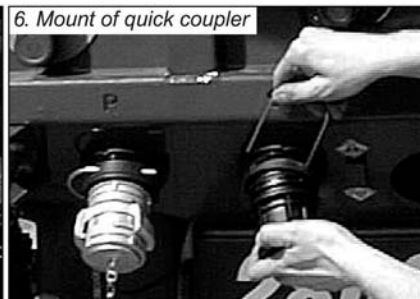
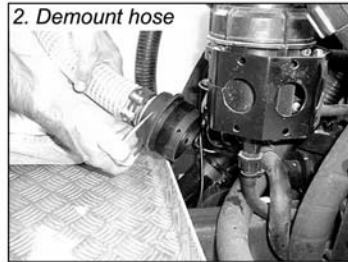

6. Tighten the nut on front side of manifold system and re-fit the external quick coupler as shown.
7. Cut the hose (from flowmeter to manifold system) to a suitable length (approx. 64 cm) and mount in manifold system.
8. Lead the flowmeter cable from display to flowmeter in a way that it will not be damaged and connect it. Secure with cable ties.
9. Re-fit MANIFOLD cover.

## **COMMANDER Plus pressure filling**

1. Remove cover from platform side of manifold system.
2. Demount the hose from the pressure filling inlet, if any.
3. Assemble all new flowmeter parts in same order as shown.
4. Mount assembled parts in the pressure inlet bush.

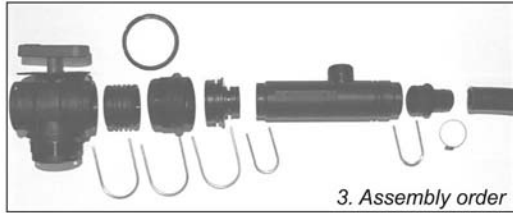

5. Lead the hose to the tank and connect (see separate section).
6. Lead the flowmeter cable from display to flowmeter in a way that it will not be damaged and connect it. Secure with cable ties.
7. Replace cover.
8. Mount the new 3-way valve on the pressure side inlet on front of the manifold system.
9. Mount quick coupler on the other end of the new valve (quick clutch dust cover mounted on picture).

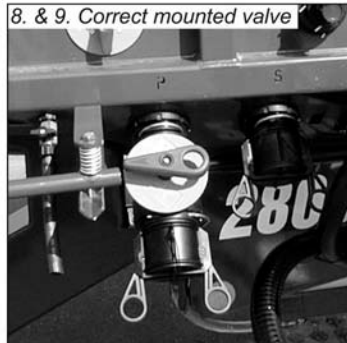

**Note:** This pressure filling system is **not** connected to the existing manifold system.

# HARDI FILLMETER

## **MEGA suction filling**

1. Remove the external quick coupler from the filling device valve.
2. Assemble new flowmeter parts.
3. Fit it in the bottom end of filling device valve.
4. Re-fit the external quick coupler on the other end of flow-meter.
5. Connect cable from flowmeter to display. Secure with cable ties.



## **MEGA pressure filling (full MANIFOLD SYSTEM)**

1. Demount the existing valve placed on the outer left end of the manifold bracket.
2. Mount the new double-hole bracket with the demounted valve on same place from where it was demounted. (Valve mounted through both brackets).
3. Mount the new pressure valve in the remaining hole of the new bracket.
4. Assemble new flow-meter parts as shown.
5. Mount assembled flowmeter in the top end of the new valve.
6. Lead hose to tank and connect (see separate section).

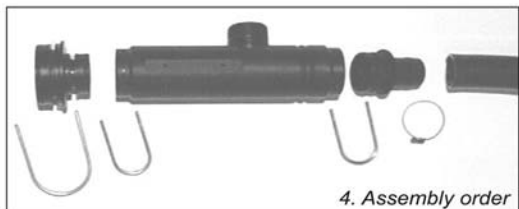
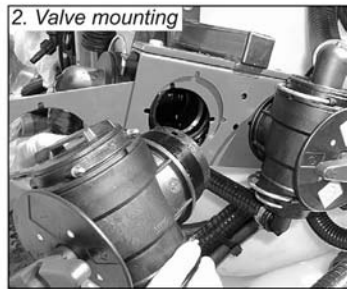



7. Connect cable from flowmeter to display. Secure with cable ties.
8. Mount the external quick coupler in the lower end of the new valve.

## **MEGA pressure filling (basic MANIFOLD SYSTEM)**

1. Mount the new pressure valve in one of the free holes on the manifold-bracket.
2. Assemble new flowmeter parts as shown.
3. Mount flowmeter in the top end of the new valve.
4. Lead hose to tank and connect. (see separate section)
5. Mount the external quick coupler in the bottom end of the new valve.
6. Connect cable from flowmeter to display and connect. Secure with cable ties.

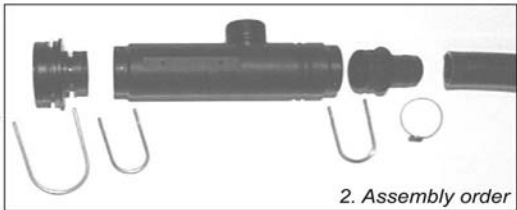
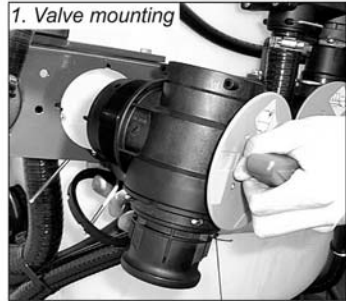

**Note:** These pressure filling systems is **not** connected to the existing manifold system.

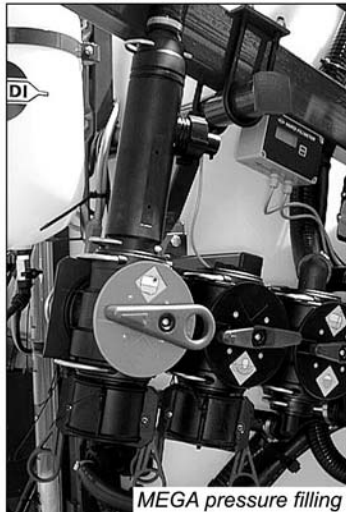

# HARDI FILLMETER

## **Mounting of air vent.**

1. Drill a 73 mm hole in the center of the lid.
2. Mount the air vent. in the lid as shown.



## **Mounting of tank connection with deflector plate in tank**



**Note:** Only actual when mounting a NURSE TANK TRANSFER SET (pressure filling).

1. Find a plane surface near the lid on the tank and assure that the filling hose can reach to this place.
2. Drill a 67 mm hole.
3. Mount lead-in with the deflector plate at the innerside of tank as shown. Make sure deflector faces away from lid.
4. Connect hose.

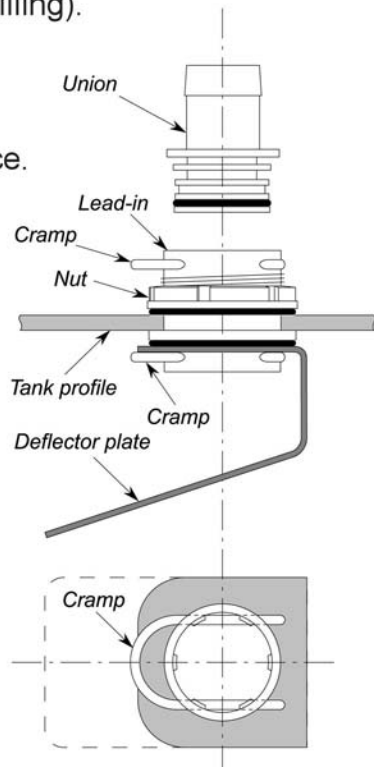

## Calibration

Before use, calibration is necessary. This may require disassembling of display and adjustment of DIP-switch. The DIP-switch is located inside the display at the upper left corner of the print plate.

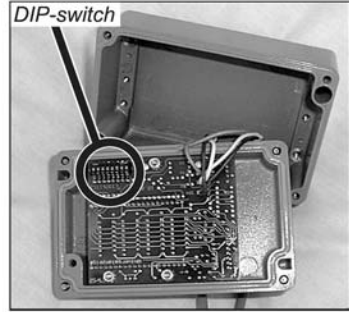

For better precision it is recommended that flow calibration is done at same flow at which the HARDI FILLMETER will be used.

## Basic setting

DIP-switch no. 7 & 8 selects the basic setting. Depending on the size of the flowmeter housing and the measuring unit being used. The standard flowmeter housing has an orifice diameter of 36 mm and the display is factory-set with switch 7 and 8 OFF.

Settings shown in diagram:

Unit	Orifice	Start value	Switch	
			7	8
Litres	36 mm	143	-	-
Litres	20 mm	499	ON	-
US gal	36 mm	143	-	ON
US gal	20 mm	499	ON	ON

Cdlib, Chart II - GB

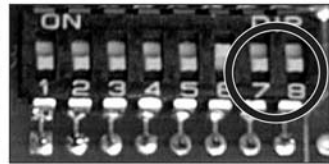

## Flow setting

The first 6 DIP-switches are used for flow calibration. The flow transducer uses impulses to 'count' the amount of liquid passing it. So there has to be a correct relation between number of impulses which is being counted per quantity unit, and what the display reading says. The DIP-switch is factory-set at 175 pulses per 10 litres (start value + added value). Added values setting shown in the diagram on page 14.

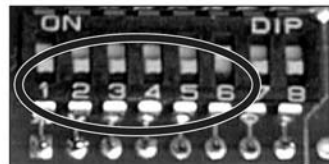

## HARDI FILLMETER

---

In-accuracy in measure can be corrected by changing the added value on the DIP switch.

This is done by measuring a known amount of water (e.g. 1000 litres). If display and actual volume do not correspond, use the following formula to calculate a new DIP-value:

$$\text{New DIP Value} = \frac{\text{Displayed Volume}}{\text{Known Calibration Volume}} \times \text{Exist. DIP Value}$$

This results in the following new added value:

$$\text{New Added Value} = \text{New DIP Value} - \text{Start Value}$$

See how to set the DIP-switches in the diagram on page 14.

### ***Example***

The Fillmeter displays a volume of e.g. 990 litres, when measuring a known value of 1000 litres. We assume that DIP-value is 175 (factory-set), therefore we calculate a new DIP-value:

$$\text{New DIP Value} = \frac{990 \text{ litres}}{1000 \text{ litres}} \times 175 = 173.25$$

This results in following new added value:

$$\text{New Added Value} = 173.25 - 143 = 30 \text{ (closest whole figure)}$$

By viewing the table (page 14), we see that switch 2, 3, 4 and 5 (of switch 1-6) should be turned ON.

### ***Procedure (example)***

1. Unscrew the display cover carefully.
2. Locate the DIP-switch on the back of the printed circuit board.
3. Set divider at 30 (switch 2, 3, 4 and 5 turned ON) with a pen.
4. Mount the display cover carefully again.
5. Test the new setting with clean water.



Do never use a pencil to change DIP settings, as it may cause a short-circuit.



Avoid damage from static electricity

1. Touch something metallic that is in contact to the ground just prior to opening and setting the DIP-switches.
2. Avoid touching the printed circuit board. Hold at the edges of the lid.



Ensure moisture does not enter the display box. It can damage electronic components.



Recalibration is required after exchange of sensor or cleaning of the housing/sensor.

# HARDI FILLMETER

## DIP-switch setup

Find the added value and set DIP-switch accordingly.

E.g. 30 impulses = switch 2,3,4 & 5 ON.

		Switch					
		1	2	3	4	5	6
<b>Added value</b>	0	-	-	-	-	-	-
	1	ON	-	-	-	-	-
	2	-	ON	-	-	-	-
	3	ON	ON	-	-	-	-
	4	-	-	ON	-	-	-
	5	ON	-	ON	-	-	-
	6	-	ON	ON	-	-	-
	7	ON	ON	ON	-	-	-
	8	-	-	-	ON	-	-
	9	ON	-	-	ON	-	-
	10	-	ON	-	ON	-	-
	11	ON	ON	-	ON	-	-
	12	-	-	ON	ON	-	-
	13	ON	-	ON	ON	-	-
	14	-	ON	ON	ON	-	-
	15	ON	ON	ON	ON	-	-
	16	-	-	-	-	ON	-
	17	ON	-	-	-	ON	-
	18	-	ON	-	-	ON	-
	19	ON	ON	-	-	ON	-
	20	-	-	ON	-	ON	-
	21	ON	-	ON	-	ON	-
	22	-	ON	ON	-	ON	-
	23	ON	ON	ON	-	ON	-
	24	-	-	-	ON	ON	-
	25	ON	-	-	ON	ON	-
	26	-	ON	-	ON	ON	-
	27	ON	ON	-	ON	ON	-
	28	-	-	ON	ON	ON	-
	29	ON	-	ON	ON	ON	-
	30	-	ON	ON	ON	ON	-
	31	ON	ON	ON	ON	ON	-

		Switch					
		1	2	3	4	5	6
<b>Added value</b>	32	-	-	-	-	-	ON
	33	ON	-	-	-	-	ON
	34	-	ON	-	-	-	ON
	35	ON	ON	-	-	-	ON
	36	-	-	ON	-	-	ON
	37	ON	-	ON	-	-	ON
	38	-	ON	ON	-	-	ON
	39	ON	ON	ON	-	-	ON
	40	-	-	-	ON	-	ON
	41	ON	-	-	ON	-	ON
	42	-	ON	-	ON	-	ON
	43	ON	ON	-	ON	-	ON
	44	-	-	ON	ON	-	ON
	45	ON	-	ON	ON	-	ON
	46	-	ON	ON	ON	-	ON
	47	ON	ON	ON	ON	-	ON
	48	-	-	-	-	ON	ON
	49	ON	-	-	-	ON	ON
	50	-	ON	-	-	ON	ON
	51	ON	ON	-	-	ON	ON
	52	-	-	ON	-	ON	ON
	53	ON	-	ON	-	ON	ON
	54	-	ON	ON	-	ON	ON
	55	ON	ON	ON	-	ON	ON
	56	-	-	-	ON	ON	ON
	57	ON	-	-	ON	ON	ON
	58	-	ON	-	ON	ON	ON
	59	ON	ON	-	ON	ON	ON
	60	-	-	ON	ON	ON	ON
	61	ON	-	ON	ON	ON	ON
	62	-	ON	ON	ON	ON	ON
	63	ON	ON	ON	ON	ON	ON

Calib. Chart 1 - GB

## Operating



**WARNING!** Do not leave the sprayer whilst filling the tank. Keep an eye on the level gauge in order **NOT** to overfill the tank!

### ***Suction filling using internal pump of the sprayer***



**WARNING!** Avoid contamination or personnel injury. Do not open suction valve towards Suction Filling Device unless pump is running and filling hose is connected. If this valve is opened without pump running, liquid may flow out of the valve.

1. Assure if the HARDI FILLMETER is connected to power source.
2. Remove cover from Suction Filling Device and connect hose.
3. Engage diaphragm pump and set P.T.O. revolutions at 540 r/min or 1000 r/min (depending on pump model).
4. Push the reset button. This resets the display, which should read 0.0.
5. Set handles as shown.
6. The tank is now being filled. Watch the display, until desired value is reached.

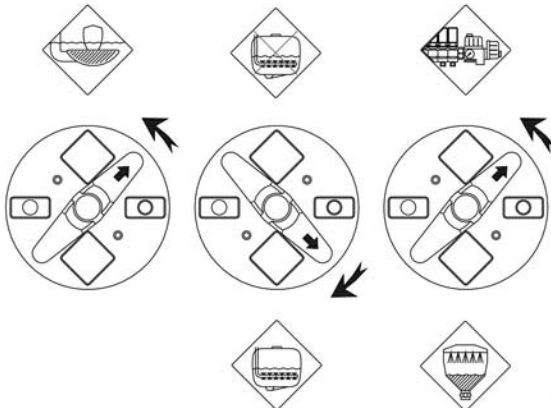

T020-0003A

## HARDI FILLMETER

---

7. Turn handle on Suction Manifold away from Filling Device to stop filling process. Then disengage pump.
8. Disconnect hose from quick coupler and put cover back.

### ***Pressure filling with external pump***

1. Assure if the HARDI FILLMETER is connected to power source.
2. Remove cover from Pressure Filling Device and connect hose.
3. Push the reset button. This resets the display, which should read 0.0.
4. Turn handle on pressure filling valve towards To Main Tank (all others closed).
5. Start filling the tank and watch the display, until desired value is reached.
6. Turn handle on valve back to "0" position again, and stop external pump.
7. Disconnect hose from quick coupler and put cover back.



It is possible to continue previous measurements, as the display counts up to 9999.9 and continues from 0.0 again.



External transfer pump pressure must not exceed 5 bar.



## Maintenance

The HARDI FILLMETER is designed for a minimum of maintenance.

Use a dry cloth to wipe off the display, if needed.



**CAUTION!** Never clean display with a high-pressure washer.

If impurities from liquid appears in flowmeter, then mount a filter on the supply hose.

After spraying season has ended, rinse the flowmeter with clean water.

## Fault finding

Fault	Solution / Problem
No reaction when turned on.	Charge tractor battery. Display works with more than 8 Volt DC but without display backlight.
No display counting when filling.	Impurities in impeller. Demount flow sensor and check if impeller rotates freely.

Fault chart - GB

# HARDI FILLMETER

## Technical specifications

### **Cable to flowmeter**

- Length = 1 m
- Plug: AMP plug
- Colour codes:
  - pin 1: White = Ground
  - pin 2: Brown = +12 V DC
  - pin 3: Green = Signal

### **Cable to power**

- Length = 7 m
- Plug: 2 POL Hella type 8JA 002 262-001
- Number of wires: 3
- Colour codes:
  - pin 1: White = Ground
  - pin 2: Brown = +12 V DC
  - pin 3: Green = Signal (HARDI NOVA only)

### **Cable from flow sensor**

- Length = 1 m
- Plug: AMP plug
- Colour codes:
  - pin 1: Black = Ground
  - pin 2: Brown = +12 V DC
  - pin 3: Blue = Signal

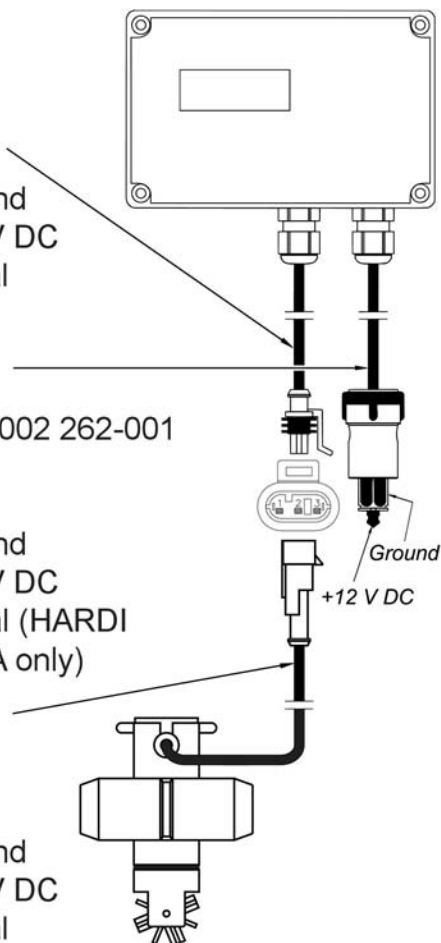

### **Power supply**

Normal supply voltage : 12 V DC

Outer limits for voltage:

Maximum supply voltage = 15 V DC

Minimum supply voltage = 10 V DC

Current at 12 V DC = <40 mA

### **Temperature**

Ambient temperature when operating = 0°C to +70°C

Storage temperature = -20°C to +70°C

### **Accuracy**

Flow rate at 200-600 l/min:  $\pm 3$  % of actual value in the complete flow range.

When calibrated at used flow level the accuracy is  $\pm 1$  %.

### **Pressure loss**

Flow house with 36 mm orifice diameter: 0.7 bar at 600 l/min

### **Calibration accuracy**

0.1 pulse per litre.

# HARDI FILLMETER

## Spare parts

### HARDI FILLMETER BASIC SET

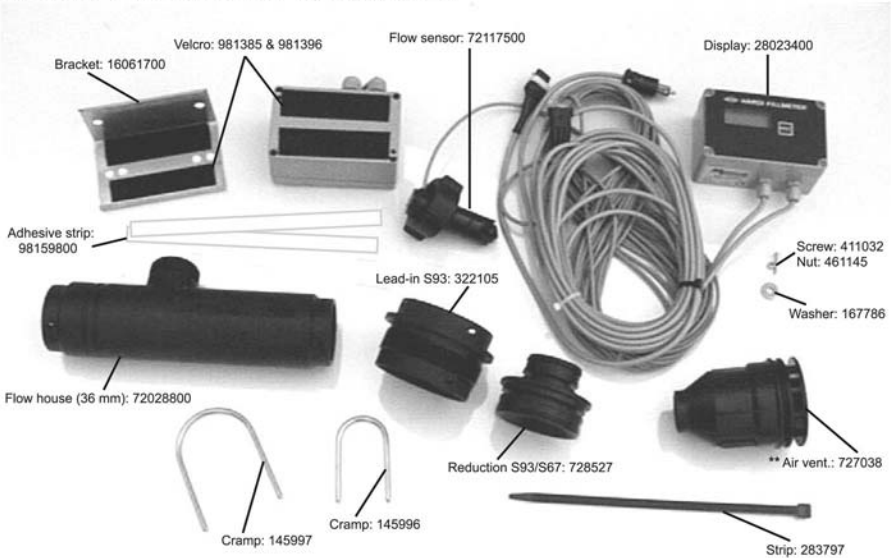

**\*\*Note:** Air vent. (no. 727038) has moved to the NURSE TANK TRANSFER set.

### HARDI FILLMETER NURSE TANK TRANSFER SET

