

**Supplement**

# **HARDI SMART VALVE**

**679045-GB-2003/05**

# SMART VALVE

## Operating the liquid system SMART VALVE SYSTEM

The SMART VALVE SYSTEM is located at the left side of the sprayer and permits operation of the liquid system from one position. The sprayer can be equipped with either a conventional liquid system or a High Capacity Fluid system. The operation of the liquid system is identical for both systems.

### Function diagrams

1. Suction filter
2. Suction manifold
3. Pump
4. Pressure manifold
5. Agitation/Rinsing valve
6. Agitation tube
7. Safety valve
8. HARDI-MATIC
9. Self-cleaning filter return
10. Self-cleaning filter
11. Check valve
12. Boom section valves
13. Boom
14. Boom pressure gauge
15. Flush tank
16. HARDI chemical inductor
17. Tank rinse nozzles
18. Pressure equalization return
19. Boom Tube Pressure relief
20. Options
21. Ball valve

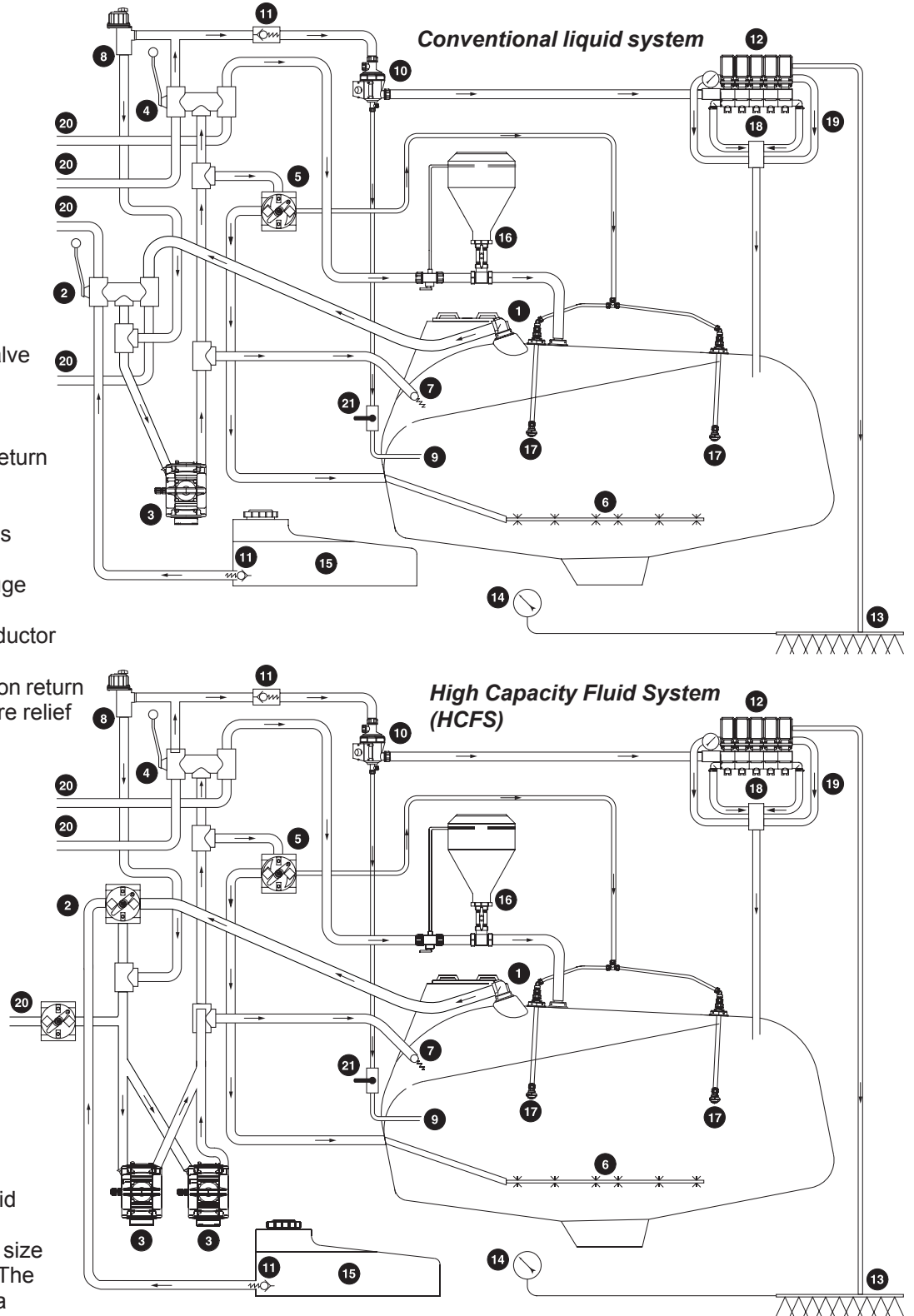

The High Capacity Liquid System is available for booms with a minimum size of 28 m working width. The HCFS is provided with a double pump (two 463 pumps joined with a clutch). The pumps have parallel outlet and feeding.

The HCFS is also provided with two self-cleaning filters, operated simultaneously via the tank. The EVC operating unit is split into two units. Tubes are made of stainless steel.

# SMART VALVE

## Use of MANIFOLD valve system

The following pictograms and colours are used for visualizing the functions of the MANIFOLD valves:

Green disc = Pressure valve  
Black disc = Suction valve

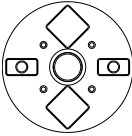

A function is activated/opened by turning the handle towards the desired function

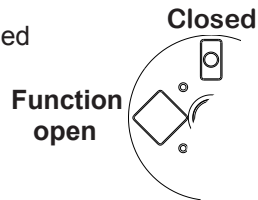

If the lever points at an unused position, then the Smart Valve will be closed.

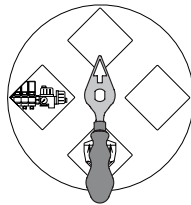

## To operate the spraying functions:



- Turn the handle on a green pressure valve towards the desired function
- Turn the handle on a black suction valve towards the desired function

**NOTE!** If a MANIFOLD valve is too tight to operate - or if it is too loose (= liquid leakage), the valve needs to be serviced. Please see the part “Occasional maintenance - Adjustment of 3-way-valve” for further information. Correct setting is when the valve can be operated smoothly by one hand







### Electric operated MANIFOLD valves (if fitted)

One or more MANIFOLD valve(s) can be electrically operated via a control box in the tractor cab. These can only be operated manually when the power to the valve motor is disconnected first.

**IMPORTANT!** If the sprayer is put aside with liquid in the main tank all MANIFOLD valves must be closed.

Pictograms - Black disc (suction)	
Suction from main tank	
Rinsing tank	
Filling device	



025

Pictograms - Green disc (pressure)	
Self-cleaning filter / Operating unit	
Fast filling device	
HARDI FILLER	
Agitation *	
Tank flushing nozzle	
To main tank	
Spray gun	

026

### \*Agitation

Normally, Agitation should be on but please refer to the following rules of thumb:

1. Close agitation if a high level of effervescence occurs in order to reduce the amount of foam.
2. Choose “Agitation” when using powder chemicals in order to avoid sedimentation. 
3. Close the valve if spraying with a high volume and it is impossible to achieve sufficient pressure or if a high level of effervescence occurs in order to reduce the amount of foam. 

The valves and functions may vary from machine to machine depending on optional equipment fitted.

# SMART VALVE

## Filling with Suction Filling Device (if fitted)

### Grip positions:

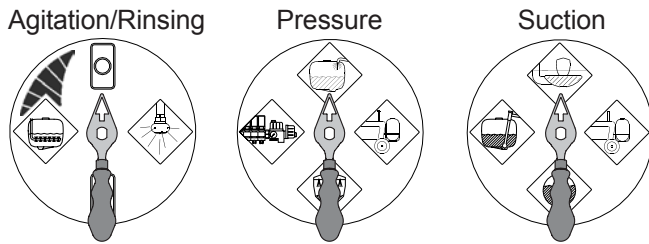

**WARNING!** Avoid contamination or personal injury. Do not open suction valve towards Suction Filling Device unless pump is running and filling hose is connected. If this valve is opened without pump running, liquid will stream out of the MANIFOLD.

The Suction Filling Device is operated as follows:

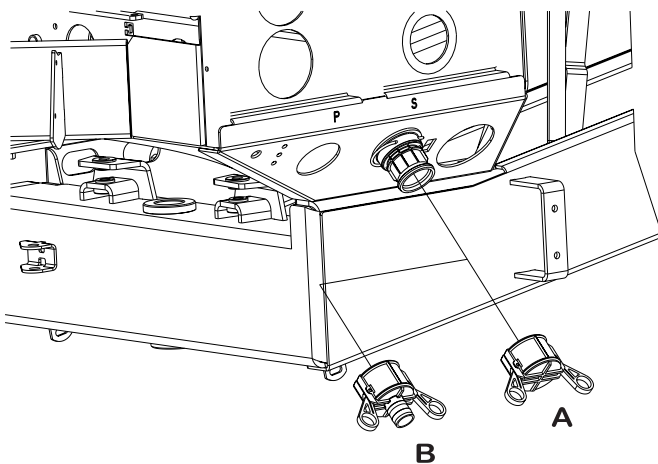

T041-0014

1. Remove cover **A**, and connect suction hose **B** to Suction Manifold.
2. Engage diaphragm pump and set P.T.O. revolutions at 540 r/min or 1000 r/min (depending on pump model)
3. Turn handle on Suction Manifold towards Filling Device.
4. The tank is now filled with water. Keep an eye on the liquid level indicator.
5. Turn handle on Suction Manifold away from Filling Device to discontinue filling process. Then disengage pump.
6. Disconnect suction tube **B** and replace cover.

**NOTE!** Observe local legislation regarding use of Filling Device. In some areas it is prohibited to fill from open water reservoirs (lakes, rivers etc.). It is recommended only to fill from closed reservoirs (mobile water tanks etc.) to avoid contamination.

**WARNING!** If suction hose/filter is carried on the sprayer during spraying, it can be contaminated by spray drift which will be transferred to lake/river when filling!

## Filling with Fast Filling Device (if fitted)

### Grip positions:

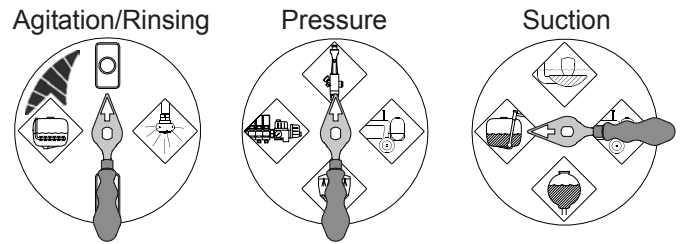

The Fast Filling Device is operated as follows:

1. Ensure spray liquid tank contains at least 50 litres of water.
2. Remove cover **(A)** and connect suction hose **(B)**.

3. Turn handle on Pressure Manifold towards Fast Filler. With the P.T.O. at 540 r/min or 1000 r/min (depending on pump model), the pressure gauge should indicate about 10 bar.
4. If water is not seen in the transfer tube, prime by turning valve **(C)**.
5. Keep an eye on the liquid level indicator.
6. Turn handle on Pressure Manifold away from Fast Filler to discontinue filling process.

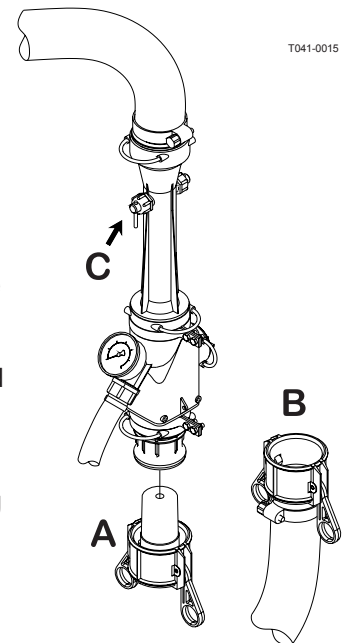

T041-0015

**NOTE!** Turn handle towards -operating unit **before** turning away from Fast Filler in order to avoid peak pressure blowing the safety valve!

7. Disconnect suction tube **(B)** and replace cover.

# SMART VALVE

## Filling device and Fast filling device used simultaneously (if fitted)

### Grip positions:

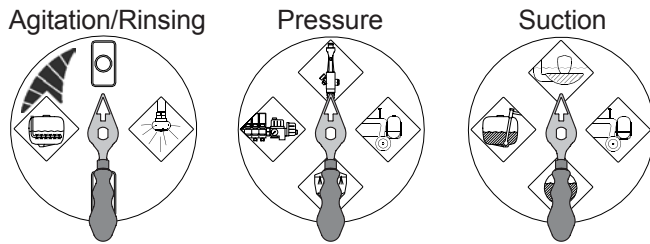

The Filling Device and the Fast Filling Device can be used simultaneously - this gives even bigger filling capacity.



**WARNING!** Do not leave the sprayer whilst filling the tank, and keep an eye on the level gauge in order **NOT** to overfill the tank!

**NOTE!** Observe local legislation regarding use of Filling Device. In some areas it is prohibited to fill from open water reservoirs (lakes, rivers etc.). It is recommended only to fill from closed reservoirs (mobile water tanks etc.) to avoid contamination.



**WARNING!** If suction hose/filter is carried on the sprayer during spraying, it can be contaminated by spray drift, which will be transferred to lake/river when filling!

## Use of Quick coupler for external filling

### Grip positions:

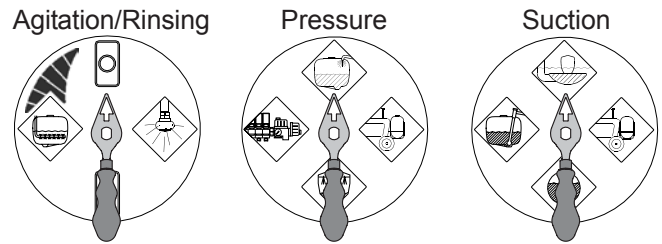

The quick coupler is operated as follows

1. Fit the external water hose to the quick coupler on the trailer.
2. Close self-cleaning filter.
3. Turn handle on Pressure Manifold towards Main tank.
4. Turn handle on Suction Manifold towards Filling device.
5. Depending on the chemical in question, the Pressure Manifold can be set on "Agitation". If no agitation is needed, this valve must be closed.
6. Engage the P.T.O. and start the pump.



**WARNING!** Do not leave the sprayer whilst refilling the tank, and keep an eye on the level gauge in order **NOT** to overfill the tank!

# SMART VALVE

## Filling of chemicals

Chemicals can be filled in the tank in two ways:

1. Through tank lid.
2. By means of HARDI FILLER chemical filling device.

### 1. Filling through tank lid

The chemicals are filled through the tank lid - Note instructions on the chemical container!



**WARNING!** Be careful not to slip or splash chemicals when carrying chemicals up to the tank lid!

1. Make sure the EVC is switched off.
2. Set the MANIFOLD valves to correct position. Black valve "Suction from main tank", upper green valve towards "Agitation".
3. Engage the pump and set P.T.O. revolutions to 540 r/min or 1000 r/min (depending on pump model).
4. Add the chemicals through the main tank hole.
5. When the spray liquid is well mixed, turn handle on the Smart Valve towards "Spraying" position. Keep P.T.O. engaged so the spray liquid is continuously agitated until it has been sprayed on the crop.

## Filling by HARDI FILLER chemical inductor

### Grip positions:

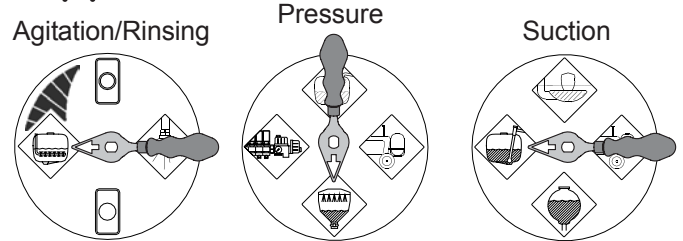

To get access to the HARDI FILLER, grab the handle and drag the HARDI FILLER the whole way down. Due to the spring loaded suspension, it will stay in this position. After use, it is pushed the whole way up again.

### Filling of Liquid chemicals

1. Fill the main tank at least  $\frac{1}{3}$  with water (unless something else is stated on the chemical container label). See section "Filling of water".
2. Turn the handle at the Suction Manifold towards "Main tank". Turn green Smart Valve towards "HARDI FILLER" and the upper green valve towards agitation. Close remaining valves.
3. Check that bottom valve **A** at the FILLER is closed.



T060-0144

4. Engage the pump and set P.T.O. speed at 540 r/min or 1000 r/min (depending on pump model).
5. Open FILLER lid.
6. Measure the correct quantity of chemical and fill it into the hopper.

**NOTE!** The scale in the hopper can only be used if the sprayer is parked at level ground! It is recommended to use a measuring jug for best accuracy.

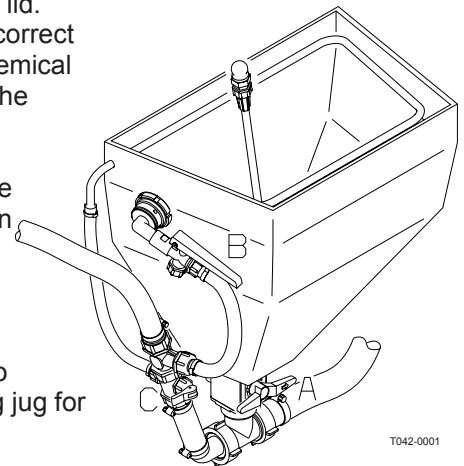

T042-0001



# SMART VALVE

- Open the bottom valve **A** and the chemical is transferred to the main tank.
- If the chemical container is empty it can be rinsed by the container rinsing device (if fitted). Place the container over the multi-hole nozzle and press the lever **B**.



**WARNING!** Do not press lever **B** unless the multi-hole nozzle is covered by a container to avoid spray liquid hitting the operator.

**IMPORTANT!** Rinsing device uses spray liquid to rinse containers for concentrated chemicals. Always rinse the chemical containers with clean water several times until they are clean before disposal.

- Engage the hopper rinsing device by opening valve **C**.
- Close valve **C** again when the hopper is rinsed.

**IMPORTANT!** The hopper rinsing device is using spray liquid for rinsing the hopper for concentrated chemical! The FILLER must always be cleaned together with the rest of the sprayer when the spray job is done.

- Close valve **A** and the FILLER lid again.
- When the spray liquid is well mixed, turn handle on the Pressure Smart Valve towards “Spraying” position. Keep P.T.O. engaged so the spray liquid is continuously agitated until it has been sprayed on the crop.

## Filling of Powder chemicals

- Fill the main tank at least  $\frac{1}{2}$  with water (unless something else is stated on the chemical container label). See section “Filling of water”.
- Turn the handle at the Suction Manifold towards “Main tank” and upper green valve towards “Agitation”. Turn the handle at the Smart Valve towards “HARD FILLER”. Close remaining valves.
- Engage the pump and increase P.T.O. speed to 540 r/min or 1000 r/min (depending on pump model).
- Open the bottom valve **A** at the FILLER. Open FILLER lid.
- Engage the hopper rinsing device by opening valve **C**.
- Measure the correct quantity of chemical and sprinkle it into the hopper as fast as the rinsing device can flush it down.

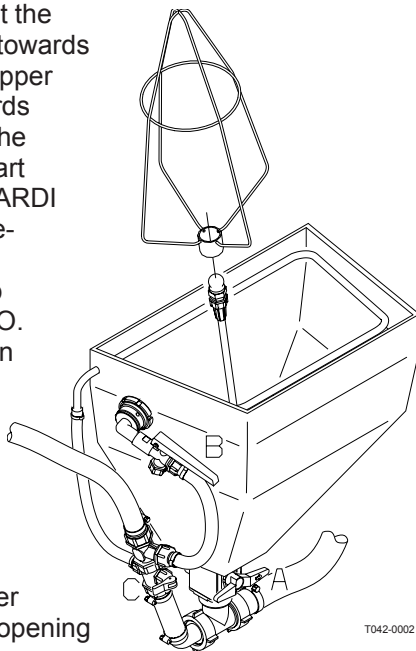

- If the chemical container is empty it can be rinsed by the container rinsing device (if fitted). Fit the bag bracket and place the powder bag over the multi-hole nozzle and press the lever **B**.



**WARNING!** Do not press lever **B** unless the multi-hole nozzle is covered by a container to avoid spray liquid hitting the operator.

**IMPORTANT!** Rinsing device uses spray liquid to rinse containers for concentrated chemicals. Always rinse the chemical containers with clean water several times until they are clean before disposal.

- Close valve **C** again when the hopper is rinsed.

**IMPORTANT!** The hopper rinsing device is using spray liquid to rinse the hopper for concentrated chemical. The FILLER must always be cleaned together with the rest of the sprayer when the spray job is done.

- Close valve **A** and the FILLER lid again.

- When the spray liquid is well mixed, turn handle on the Pressure Smart Valve towards “Spraying” position. Keep P.T.O. engaged so the spray liquid is continuously agitated until it has been sprayed on the crop.

# SMART VALVE

## Spraying

### Grip positions while spraying with agitation:

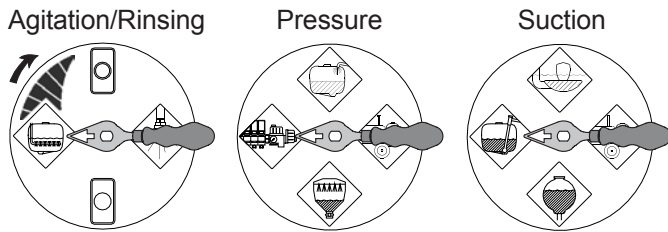

Use Adjustable Agitation to adjust the needed amount of agitation related to selected spraying volume.

### Grip positions while spraying without agitation:

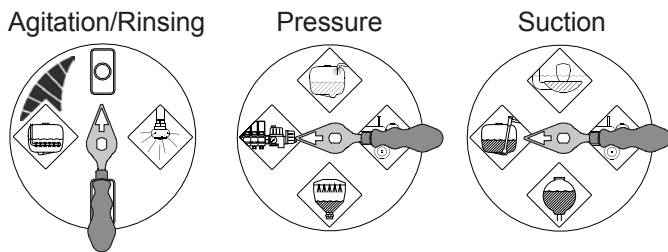

**Spray Technique - see separate book**

## Use of rinsing tank and rinsing nozzles (if fitted)



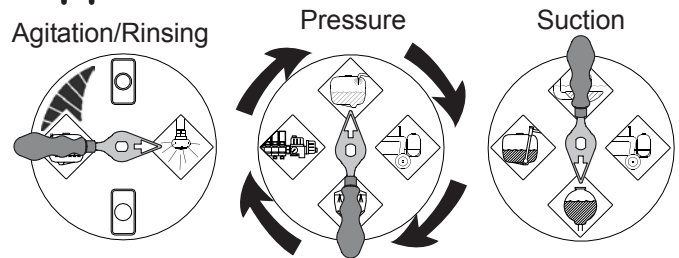

### Grip positions:

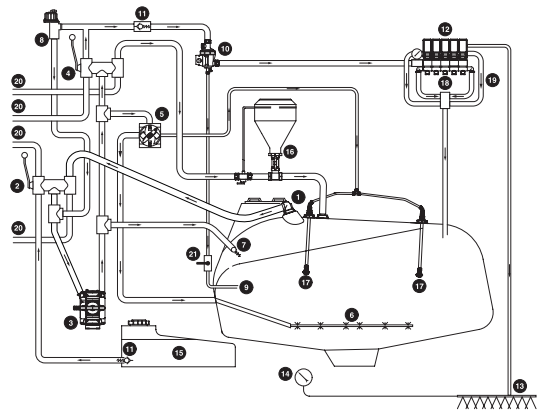

The incorporated rinsing tank can be used for two different purposes.

A. In-field diluting of remaining spray liquid residue in the spraying circuit for spraying the liquid in the field, before cleaning the sprayer.



1. Empty the sprayer as much as possible. Close the upper green pressure valve (no agitation) and spray till air comes out of all nozzles.
2. Turn black suction valve towards "Rinsing tank". 
3. Turn upper green pressure valve towards "Rinsing nozzle" (if fitted). 
4. Engage and set the pump at approximately 300 r.p.m.
5. When rinsing water corresponding to approximately 1/3 of rinsing tank content is used, turn black suction valve towards "Suction from main tank" and operate all valves, so all hoses and components are rinsed. 
6. Turn green Smart Valve back to "Operating unit" and spray liquid in the field you have just sprayed. 
7. Repeat point 3-7 until the rinsing tank is empty.



# SMART VALVE

B. Rinsing the pump, operating unit, spray lines, etc. in case of stop in spraying before main tank is empty (e.g. beginning rain etc.).

1. Close Self-cleaning filter (Ballofix).
2. Turn black suction valve towards "Rinsing tank".
3. Close upper green pressure valve (no agitation).
4. Engage the pump and spray water from rinsing tank in the field until all nozzle tubes/nozzles are flushed with clean water.
5. Disengage pump again.
6. Open Self-cleaning filter again.



**WARNING!** The rinsing nozzles cannot always guarantee a 100% cleaning of the tank. Always clean manually with a brush afterwards, especially if crops sensitive to the chemical just sprayed are going to be sprayed afterwards!

## Safety precautions



**Always be careful when working with crop protection chemicals!**

## Personal protection

Dependant on which type of chemical used, the following protective clothing/equipment should be used:

- Gloves
- Waterproof boots
- Headgear
- Respirator
- Safety goggles
- Chemical resistant overall

This equipment should be worn to avoid contact with the chemicals.



Protective clothing/equipment should be used when preparing the spray liquid, during the spraying work and when cleaning the sprayer. Also follow the recommendations on the chemical label.



It is always advisable to have clean water available, especially when filling the sprayer with the chemical.



Always clean the sprayer carefully and immediately after use.



Do not mix different chemicals in the tank.



Always clean the sprayer before changing to another chemical.

# SMART VALVE

## MANIFOLD Quick Reference

**Grip positions**

**Water filling**

**Chemical filling**

**Spraying**

**Cleaning**  
Aspirate 1/3 of rinsing tank content

**Operate all functions**

**Repeat 3 times**

**Spray out all the diluted tank content**

97804800

**HARDI**  
www.hardi-international.com

1 2 3  
a b c d  
a b c d  
a b c d

# SMART VALVE

## Spare parts

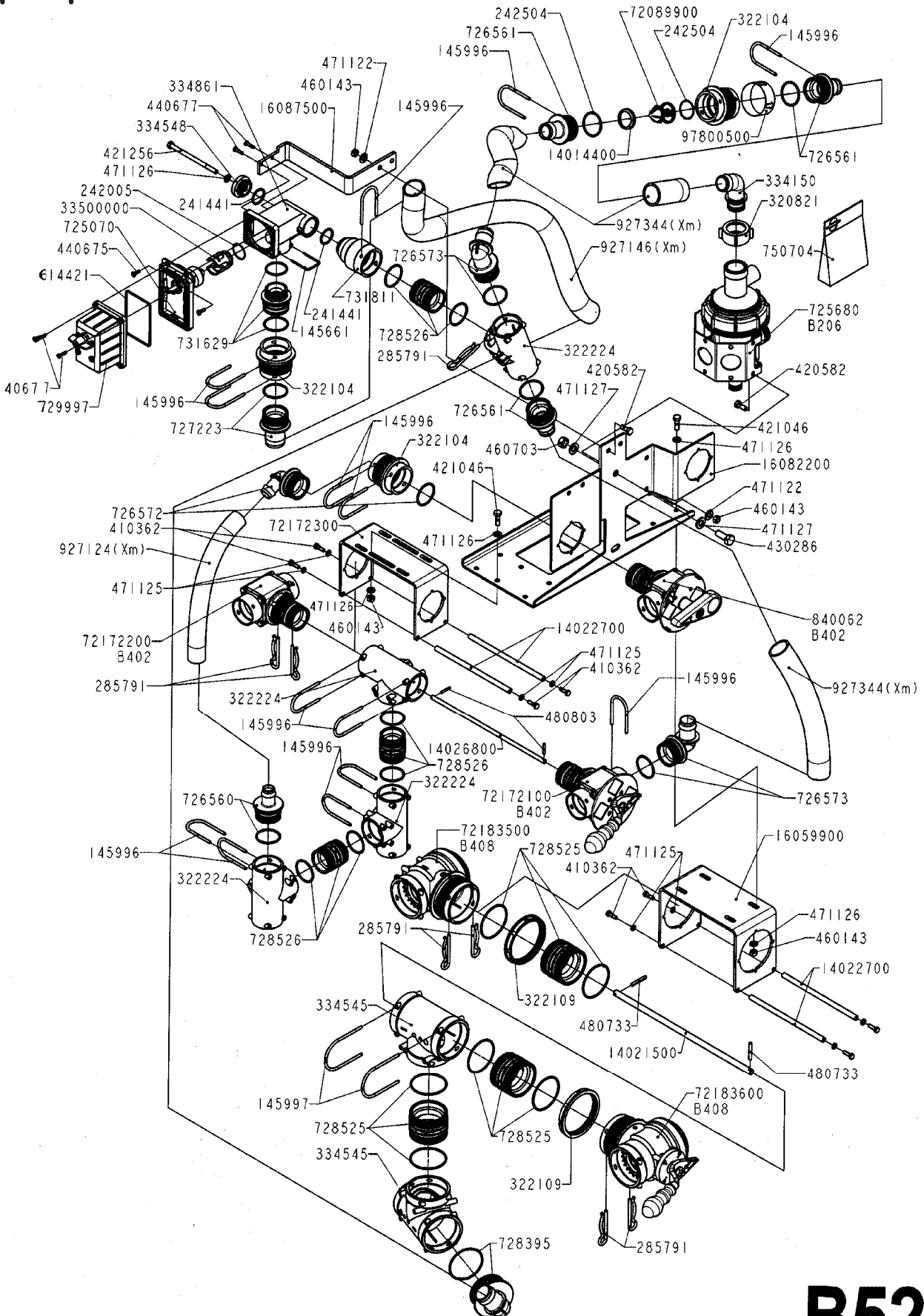

# B524