



**CP5/CP8**

**MAXI PRO**

673005-2002.03



**EC Declaration of Conformity**  
**EU-overensstemmelseserklæring**  
**EG-Konformitätserklärung**  
**Déclaration CE de Conformité**  
**Declaración de conformidad de la CE**  
**Dichiarazione di Conformità CE**  
**Declaração de conformidade da CE**  
**EU-Yhdenmukaisuus julistus**  
**CE Conformiteitsverklaring**  
**EU-Enhetsdeklaration**  
**EU- overensbestemmelseserklæring**

Manufacturer • Fabrikant • Hersteller • Constructeur • Fabricante • Costruttore •  
Valmistaja • Fabrikat

**HARDI INTERNATIONAL A/S**

Helgeshøj Allé 38  
DK 2630 Taastrup  
DENMARK

Importer • Importør • Importeur • Importateur • Importador • Importatore •  
Maahantuojaja • Importeur

Declare that the following product :  
Erklærer hermed, at følgende produkt:  
Erklært hiermit, daß das folgende Produkt:  
Déclare par la présente que le produit suivant:  
Por la presente declara, que el producto siguiente:  
Dichiara che il seguente prodotto:  
Declara que o seguinte produto:  
Täten todistamme, että seuraava tuote:  
Verklaart dat het volgende produkt:  
Deklarerar härmed, att följande produkt:  
Erklærer herved, at følgende produkt:

.....  
.....



Adhere extra shipping package labels to inside cover.  
Klæb ekstra forsendelsesetiketter på indersiden af omslaget.  
Extra Versandetikett auf der Innenseite des Umschlages einkleben.  
Collez des étiquettes supplémentaires à l'intérieur de la couverture.  
Pegar etiketas de envío al lado interior de la cubierta.  
Attaccare delle ulteriori etichette di spedizione all'interno della copertura.  
Colar os autocolantes suplementares no interior da cobertura.  
Lisälähetysohjeita on liimattava pakkauksen sisäpuolelle.  
Plak de extra verzendetiketten aan de binnenzijde van de omslag.  
Klistra extra försändelseetikett på insidan av omslaget.  
Kleb ekstra forsendelsesetiketter på innsiden av omslaget.

**GB**

**A.** was manufactured in conformity with the provisions in the COUNCIL DIRECTIVE of 14 June 1989 on mutual approximation of the laws of the Member States on the safety of machines (89/392/EEC as amended by directives 91/368/EEC and 93/368/EEC) with special reference to Annex 1 of the Directive on essential safety and health requirements in relation to the construction and manufacture of machines.

**B.** was manufactured in conformity with the standards current at that time that implements a harmonised standard in accordance with Article 5 (2) and other relevant standards.

**DK**

**A.** er fremstillet i overensstemmelse med bestemmelserne i RÅDETS DIREKTIV af 14. juni 1989 om indbyrdes tilnærmelse af medlemsstaternes lovgivning om maskiner (89/392/EØF og ændret ved 91/368/EØF og 93/368/EØF) under særlig henvisning til direktivets bilag I om væsentlige sikkerheds- og sundhedskrav i forbindelse med konstruktion og fremstilling af maskiner.

**B.** er fremstillet i overensstemmelse med på fremstillingstidspunktet gældende standarder, der gennemfører en harmoniseret standard ifølge artikel 5, stk. 2 og andre gældende standarder.

**D**

**A.** in Übereinstimmung mit den Bestimmungen der RICHTLINIE DES RATES vom 14. Juni 1989 zur Angleichung der Rechtsvorschriften der Mitgliedstaaten für Maschinen (89/392/EWG, geändert durch die Richtlinien 91/368/EWG und 93/368/EWG) unter besonderem Hinweis auf Anhang 1 der Richtlinie über grundlegende Sicherheits- und Gesundheitsanforderungen bei Konzipierung und Bau von Maschinen, hergestellt wurde.

**B.** in Übereinstimmung mit gegenwärtigen Normen hergestellt wurde, die eine harmonisierte Norm gemäß Artikel 5 Absatz 2 und anderen zweckdienlichen Normen umsetzt:

**F**

**A.** a été construit en conformité avec les dispositions de la DIRECTIVE DU CONSEIL du 14 juin 1989 concernant le rapprochement des législations des Etats membres relatives à la sécurité des machines (89/392/CEE modifiée par les directives 91/368/CEE et 93/368/CEE) avec référence particulière à l'annexe I de la directive concernant les exigences essentielles de sécurité et de santé relatives à la conception et à la construction des machines.

**B.** a été construit en conformité avec les normes en application au moment de la fabrication qui constituent une norme harmonisée selon l'Article 5 (2) et autres normes utiles.

**E**

**A.** ha sido fabricado según las disposiciones de la DIRECTIVA DEL CONSEJO de 14 de junio de 1989 de aproximación mutua de la legislación de los estados miembros de la seguridad de maquinaria (89/392/CEE modificada por la Directiva 91/368/CEE y 93/368/CEE) con referencia especial al Suplemento 1 de la Directiva que especifica las demandas esenciales de seguridad y sanidad en relación con la construcción y fabricación de maquinaria.

**B.** está fabricado en conformidad con las normas válidas en el momento de su fabricación, que establecen una norma armonizada según artículo 5, 2 ó otras normas relacionadas:

**I**

**A.** E' stato costruito in conformità con le disposizioni della DIRETTIVA DEL CONSIGLIO del 14 Giugno 1989 concernente l'approssimazione delle leggi degli Stati membri relative alla sicurezza delle macchine (89/392/CEE modificata con le direttive 91/368/CEE e 93/368/CEE) con riferimento particolare all'Annesso I della direttiva riguardante le esigenze essenziali della sicurezza e della salute, relative alla concezione ed alla costruzione delle macchine.

**B.** E' stato costruito in conformità alle norme vigenti al momento della produzione e che realizza una norma in armonia con Articolo 5 (2) e le altre relative.

**P**

**A.** foi fabricado em conformidade com as disposições da DIRECTIVA DO CONSELHO de 14 de Junho de 1989 sobre a mutua aproximação da legislação dos Estados Membros sobre segurança de máquinas (89/392/ECC, modificada pelas directivas 91/368/ECC e 93/368/ECC) com referencia especial ao Anexo 1 da Directiva que especifica requisitos essenciais de segurança e higiene em relação com a construção e fabrico de máquinas.

**B.** foi fabricada em conformidade com as normas válidas à data de fabrico, que estabelecem uma norma harmonisada segundo o artigo 5 (2) bem como outras normas relevantes.

**FIN**

**A.** on valmistettu yhdenmukaisesti EU NEUVOSTON 14. kesäkuuta 1989 EU -jäsenmaille antamien DIREKTIIVIEN mukaan, koskien kone-lainsäädäntöä (89/992/EEC, muutettu 91/368/EEC ja 93/368/EEC) erityisesti viitaten direktiivien liitteeseen nro 1 koskien työsuojelu- ja työterveyshuolto-lainsäädäntöä koneiden kehityksessä ja valmistuksessa

**B.** on valmistettu yhdenmukaisesti valmistusajankohtana voimassa olevien standardien mukaisesti ja noudattaa 5. artiklan 2. kappaletta ja muita voimassa olevia standardeja

**NL**

**A.** is geproduceerd conform de eisen, gesteld in de MACHINE RICHTLIJN van 14 juni 1989, volgens de wetten van de aangesloten landen betreffende de veiligheid van machines (89/392/EEG, gewijzigd door de richtlijnen 91/368/EEG en 93/368/EEG), met speciale verwijzing naar de eerste bijlage van de Richtlijn betreffende de veiligheden, gezondheidseisen, in relatie tot de constructie en produktie van machines.

**B.** Is geproduceerd conform de huidige standaards, overeenstemmend met Artikel 5 (2) en andere relevante voorschriften.

S

**A.** Är framställd i överensstämmelse med bestämmelserna i MASKIN DIREKTIVET av 14 juni 1989 om inbördes närmande av medlemsstaternas lagstiftning om maskiner (89/392/EÖF och ändrat vid 91/368/EÖF och 93/368/EÖF under särskild hänvisning till direktivets bilaga i om väsentliga säkerhets- och hälsokrav i förbindelse med konstruktion och framställning av maskiner.

**B.** Är framställd i överensstämmelse vid tillverkningsstidpunktens gällande standarder. Produkten är anpassad i enlighet med artikel 5, stycke 2 och andra gällande standarder.



N

**A.** er framstilt i overensbestemmelse med bestemmelsene i RÅDETS DIREKTIV av 14. juni 1989 om innbyrdes tilnærmede av medlemsstatenes lovgivning om maskiner (89/392/EØF og 93/368/ under særlig henvisning til direktivets bilag 1 om vesentlige sikkerhets og sunnhetskrav i forbindelse med konstruksjon og framstilling av maskiner.

**B.** er framstilt i overensbestemmelse med på framstillingstidspunktet gjeldene standarder, som gjennomfører en harmonisert standard ifølge artikkel 5, stk. 2 og andre gjeldene standarder.

Taastrup 12.03.2002

Lars Bentsen

HARDI INTERNATIONAL A/S



# Assembly • Montage • Montage • Montering

**Vigtig! Important! Wichtig! Importante!**

**DK** Ved montage og 2 gange om året.

**GB** At assembly then twice a year.

**F** A l'assemblage, puis deux fois par an.

**D** Bei Montierung und zweimal jährlich.

**E** Al montar y dos veces al año.

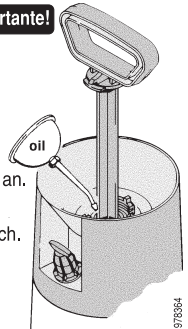

9716364

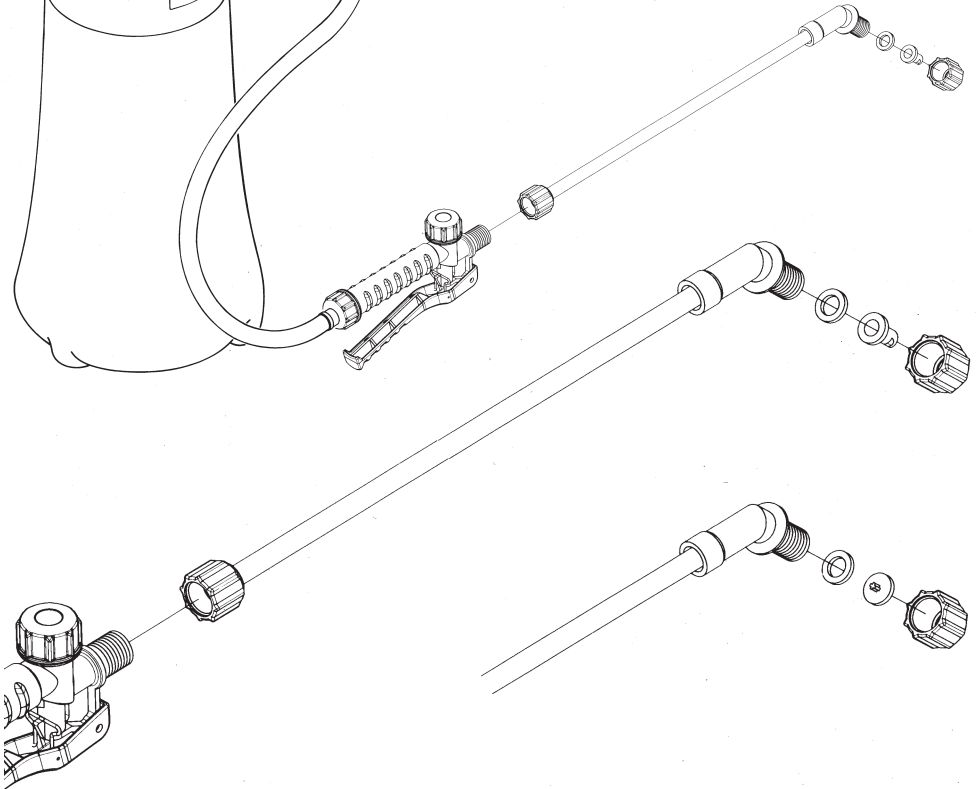
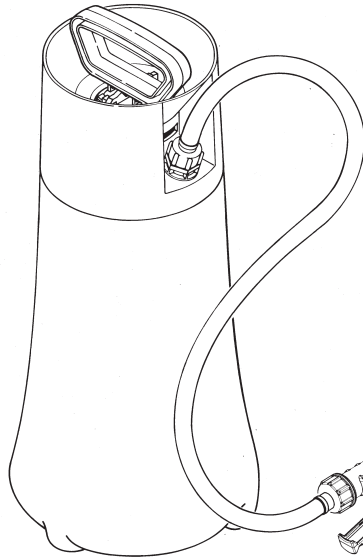

**Operation • Functonamiento • Wirken •  
Fonctionnement • Funktion**



1

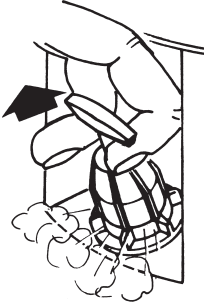

0 bar / PSI

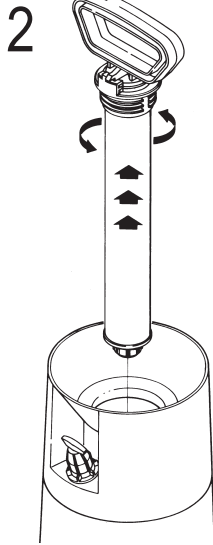

C5: 5l/1.1 imp.gal./1.3 US gal.  
C8: 8l/1.8 imp.gal./2.1 US gal.

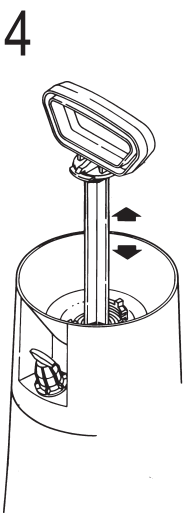

4 bar / 60 PSI max.

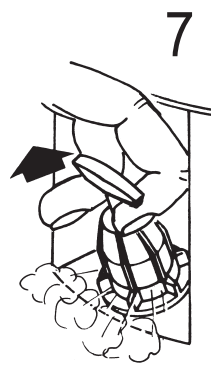
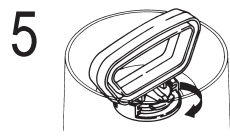

0 bar / PSI



**Safety • Seguridad • Sicherheit • Securite • Sikkerhed**



**ATTENTION!!**

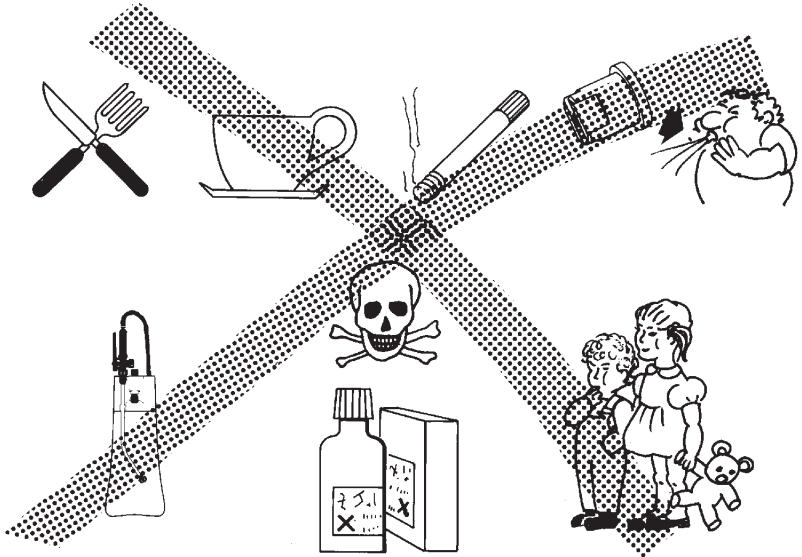
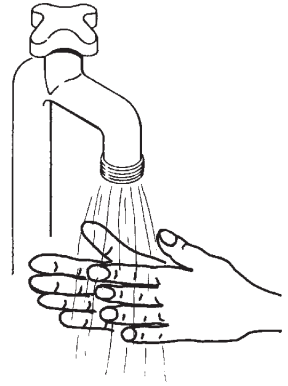
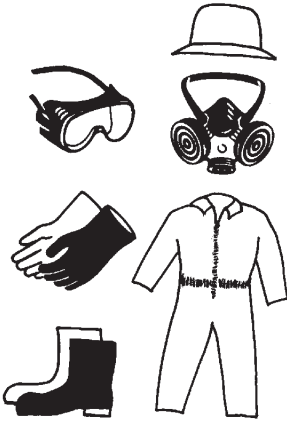
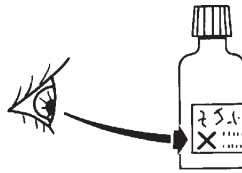



**Nozzle choice • Selección de boquillas •  
Düsenwahl • Choix des buses • Dysevalg**



**INSECTICIDES  
FUNGICIDES**

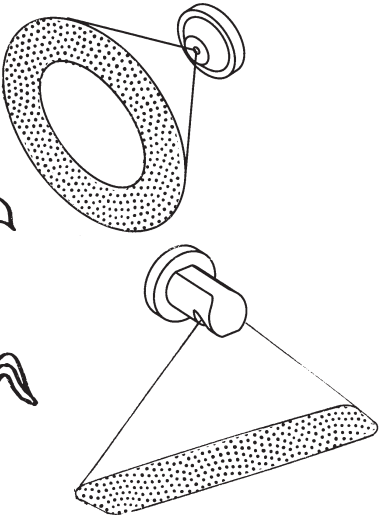

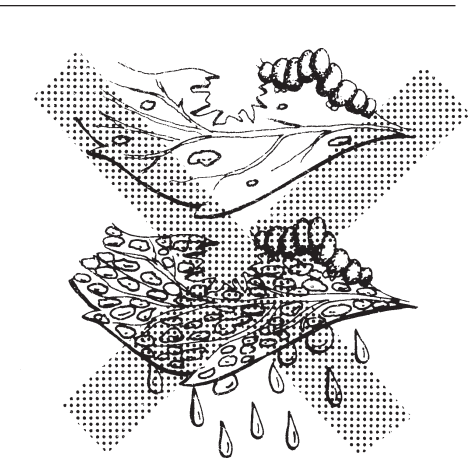
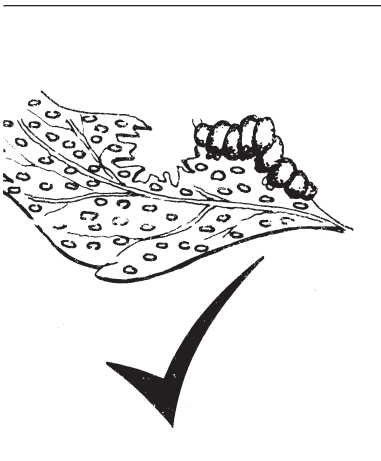

**HERBICIDES**



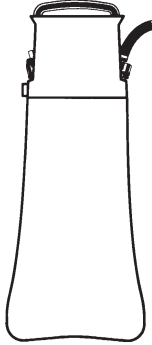
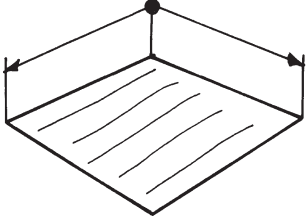

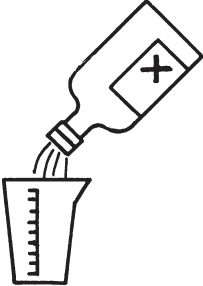
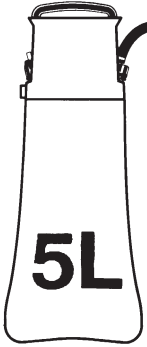
				
Litre	Imp. gal	US gal.	m <sup>2</sup>	yds
5	1.1	1.3	250	300
8	1.8	2.1	400	480

 <p>milli- litre/gram</p> <hr style="width: 100%;"/> <p>1 litre</p>	%	millilitre/gram TOTAL	
		 <p><b>5L</b></p>	 <p><b>8L</b></p>
1.0	0.1	5.0	8.0
1.5	0.15	7.5	12.0
2.0	0.2	10.0	16.0
2.5	0.25	12.5	20.0
3.0	0.3	15.0	24.0

Operation • Funcionamiento • Wirken •  
 Fonctionnement • Funktion



	ml g oz <hr/>		m <sup>2</sup> sq.yds
Weedexo	10ml/5 litres	372021	125m <sup>2</sup>



# Cleaning • Limpieza • Reinigung • Nettoyage • Rengøring



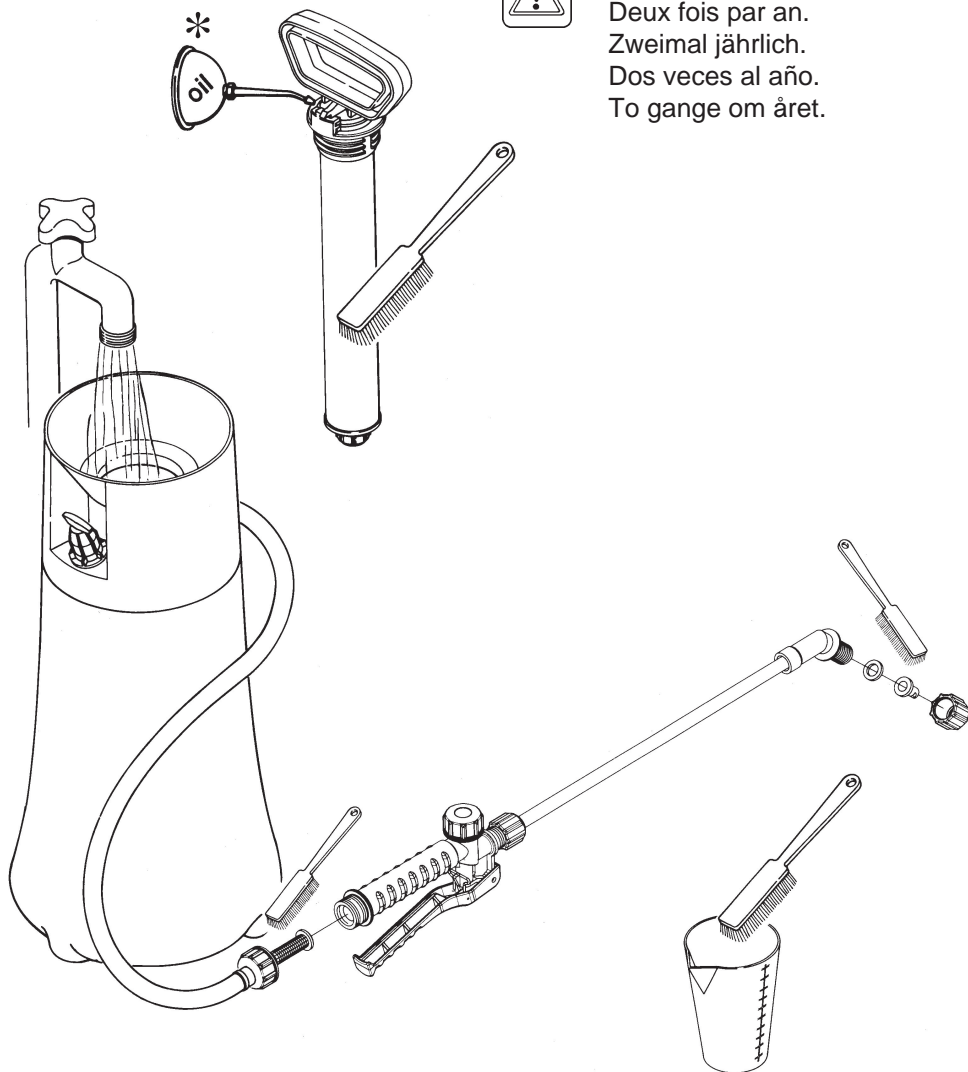

\* Twice a year.  
Deux fois par an.  
Zweimal jährlich.  
Dos veces al año.  
To gange om året.



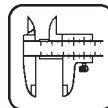

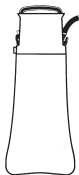
**Specifications • Especificaciones • Spezifikation  
• Specification • Specifikationer**

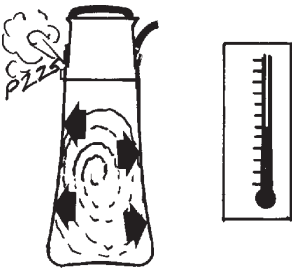

					
	kg	lb	litre	Imp.gal.	US. gal
C5	2.2	4.9	5	1.1	1.3
C8	2.6	5.7	8	1.8	2.1

	MAXIMUM
	4 bar / 60 psi
	40°C / 105°F

		1 bar / 15 psi
	Green, Verde, Vert, Grün, Grøn 372021	1.2 l/m
		3 bar / 45 psi
	Yellow, Jaune, Gelb, Amarillo, Gul 371694	0.83 l/min

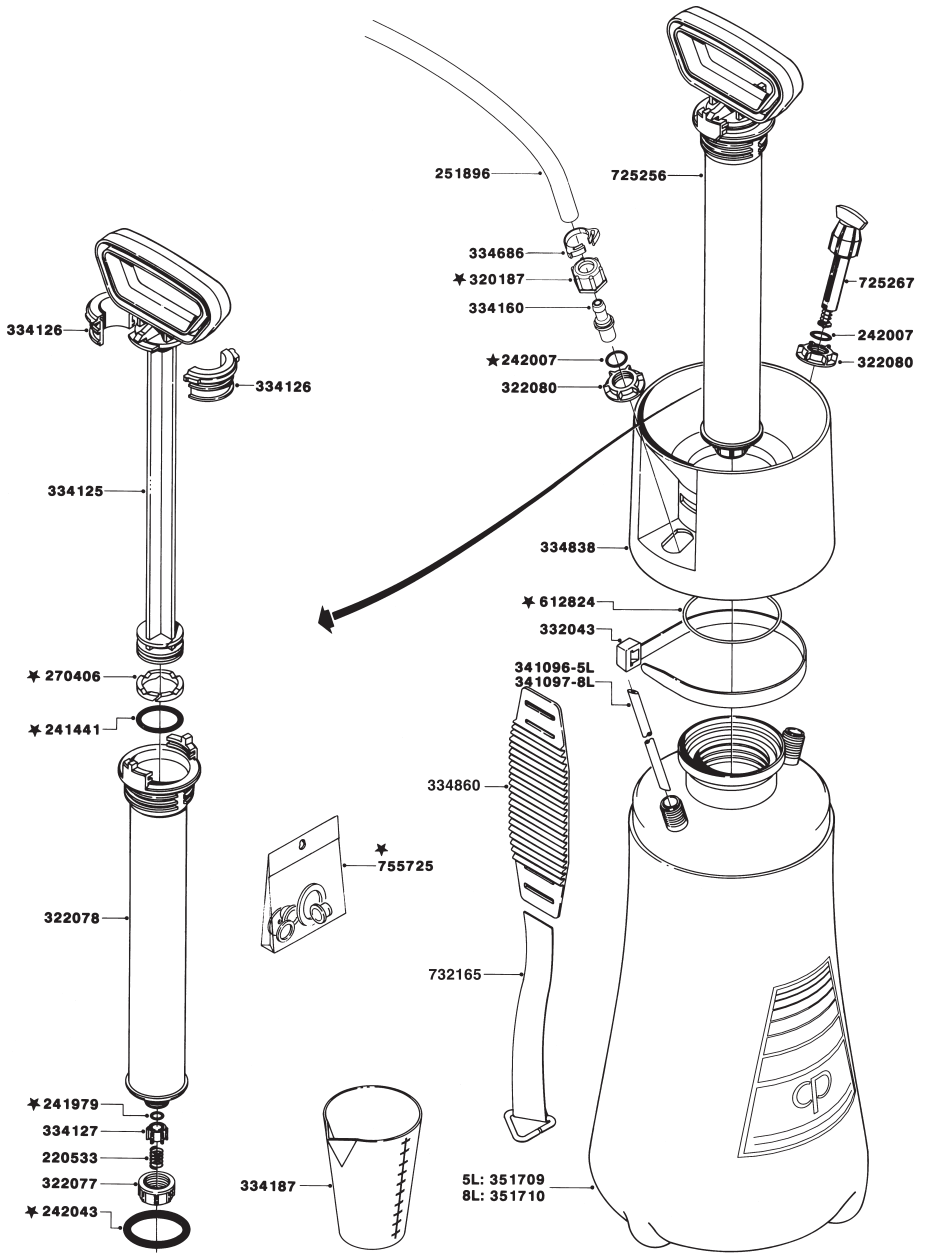

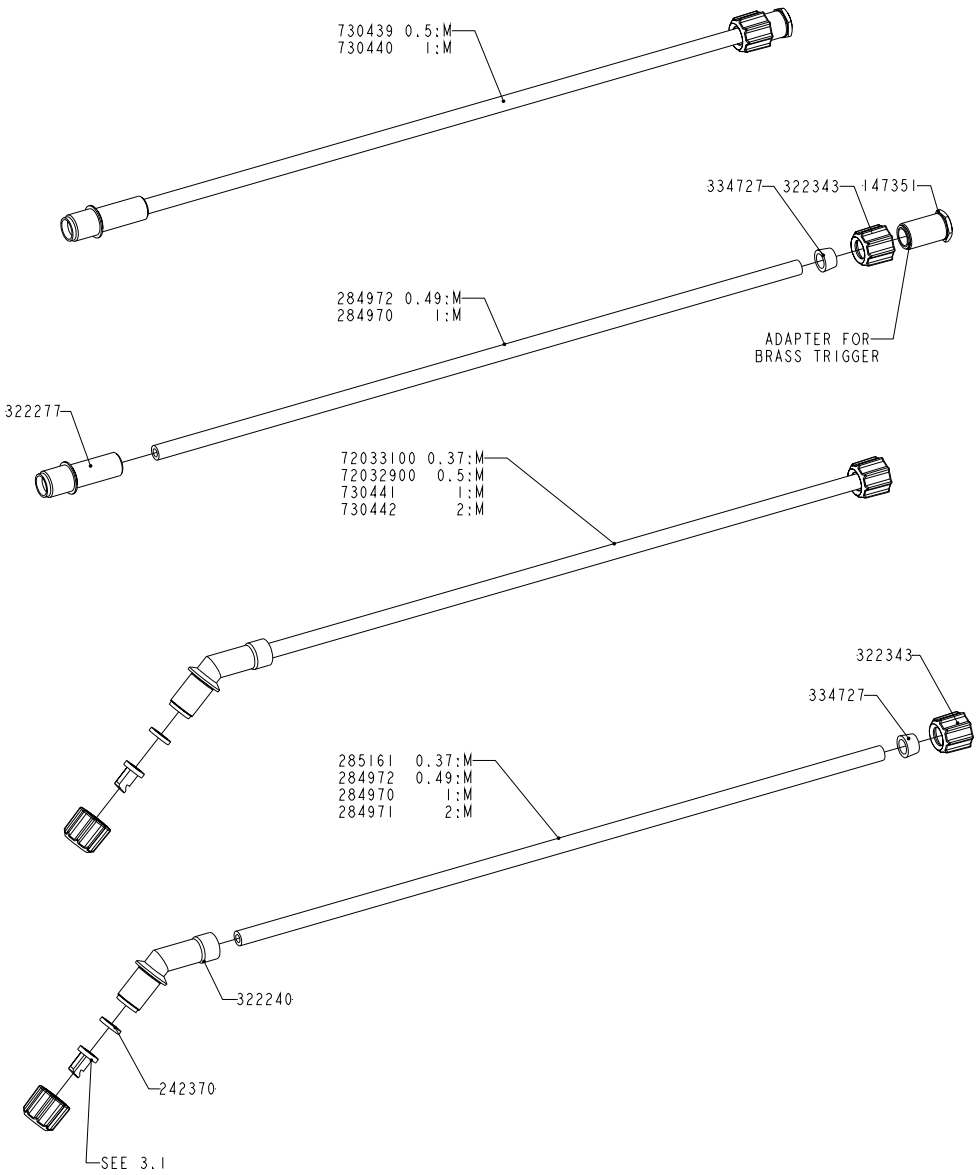

**Lances**

06.02.00

**2-4**

M17.6x1.5 730127  
M18x1.5 72032500

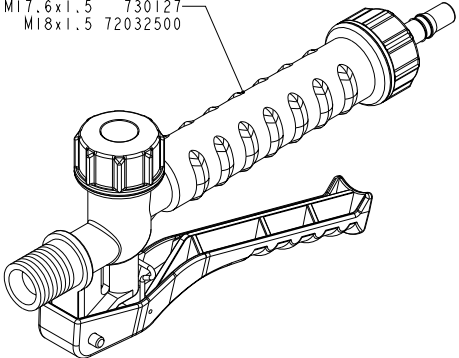

322279

755600

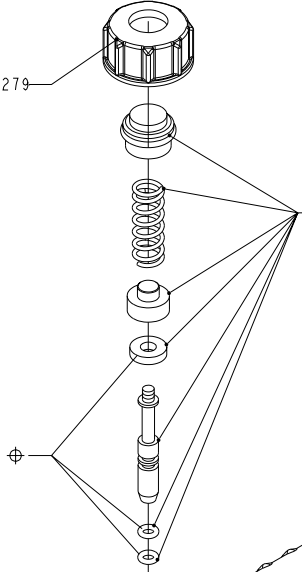

322279

M17.6x1.5 322280  
M18x1.5 322342

⊕ 750405  
CP15  
CP15 Classic  
CP3 Classic  
SEE ALSO 8.1 + 8.2

⊕ 750308  
CP15-2000  
CP3-2000  
SEE ALSO 8.4

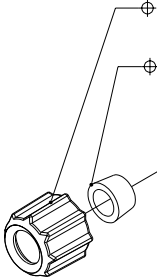

285122

334724

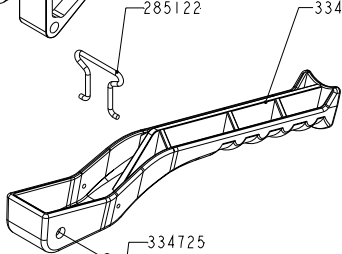

334725

