

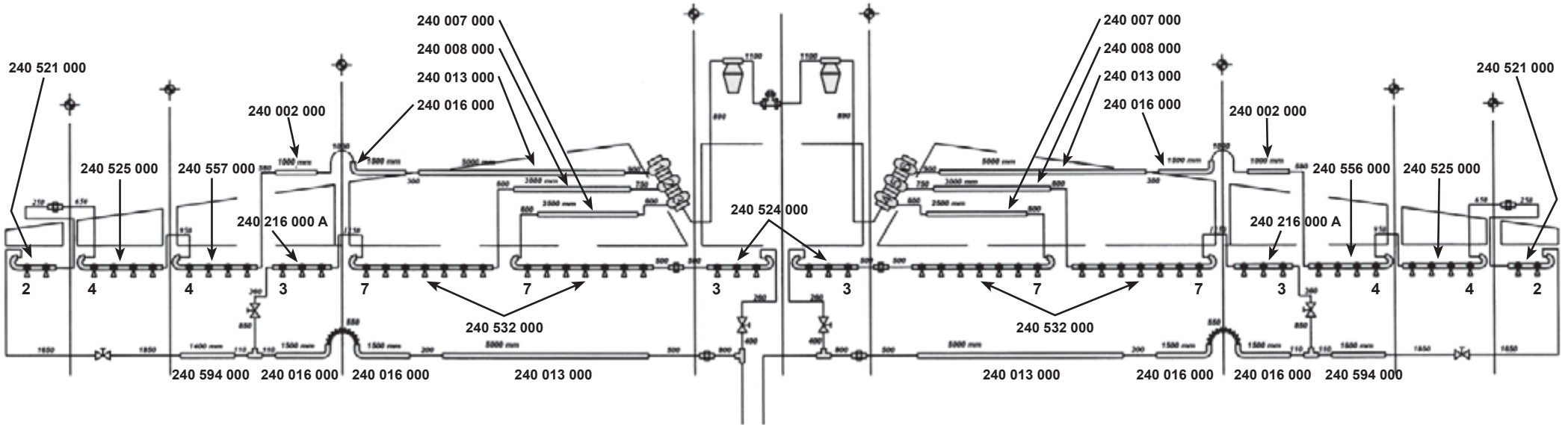





QUADRIJET NOZAL  
PENTAJET NOZAL

GAUCHE  
LEFT

DROITE  
RIGHT



-  — 240 209 000 Quadrijet NOZAL QUADRIX
-  — 240 210 000 Pentajet NOZAL
-  — 240 033 000 Vanne manuelle équipée (Manual valve)
-  — 240 035 000 «T» équipé (Tee hose)
-  — 240 176 000 «T» à vis équipé (Male Tee)
-  — 240 034 000 Raccord équipé (Connector)
-  — 240 178 000 Vanne motorisée équipée (Electric control valve)
-  — 237 659 000 Ressort (spring)
-  — 240 177 000 Filtre équipé (filter)

237 762 000 Réf. au mètre - Tuyau de retour / d'alimentation Ø19  
237 876 000 Réf. au mètre - Tuyau d'alimentation Ø30

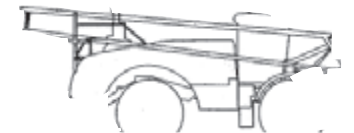

CATALOGUE MAESTRIA  
RAMPE AV 2004

Nb de jets par tronçons de gauche à droite  
No of nozzle per sections from left to right

10 - 10 - 10 - 10 - 10 - 10  
10 - 10 - 10 - 10 - 10 - 10

RAMPE ÉQUIPÉE 28/30 M 6 TRONÇONS  
28/30 M 6 SECTIONS BOOM



11  
B06  
26/10/05